

DATA SHEET

SKY73084-11: 300 to 500 MHz High Gain and Linearity Diversity Downconversion Mixer

Applications

- 2G/3G base station transceivers:
 - GSM/EDGE, CDMA, UMTS/WCDMA
- Land mobile radio
- High performance radio links

Features

- Operating frequency range: 300 to 500 MHz
- IF frequency range: 50 to 250 MHz
- Conversion gain: 9.8 dB
- Input IP3: +25.2 dBm
- Output IP3: +35 dBm
- Noise figure: 9.4 dB
- Integrated LO drivers
- Integrated low loss RF baluns
- High linearity IF amplifiers
- On-chip SPDT LO switch (greater than 60 dB LO-to-LO isolation)
- Small, MCM (36-pin, 6 x 6 mm) Pb-free package (MSL3, 260 °C per JEDEC J-STD-020)



Skyworks Green™ products are compliant with all applicable legislation and are halogen-free. For additional information, refer to *Skyworks Definition of Green™*, document number SQ04-0074.

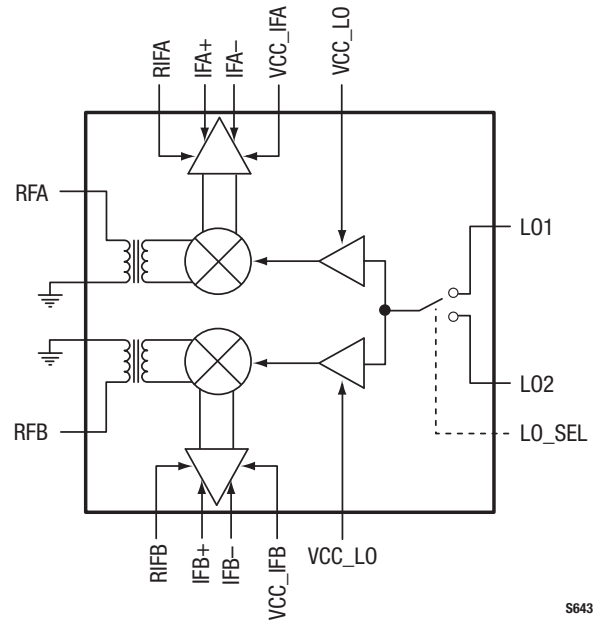

Figure 1. SKY73084-11 Block Diagram

Description

The SKY73084-11 is a fully integrated diversity mixer that includes local oscillator (LO) drivers, an LO switch, high linearity mixers, and large dynamic range intermediate frequency (IF) amplifiers. Low loss RF baluns have also been included to reduce design complications and lower system cost.

The SKY73084-11 features an input IP3 of +25.2 dBm and a noise figure (NF) of 9.4 dB, making the device an ideal solution for high dynamic range systems such as 2G/3G base station receivers. The LO switch provides more than 60 dB of isolation between LO inputs and supports the switching time required for GSM/EDGE base stations.

The SKY73084-11 is manufactured using a robust silicon BiCMOS process and has been designed for optimum long-term reliability. The SKY73084-11 diversity downconversion mixer is provided in a compact, 36-pin Multi-Chip Module (MCM). A functional block diagram is shown in Figure 1. The pin configuration and package are shown in Figure 2. Signal pin assignments and functional pin descriptions are provided in Table 1.

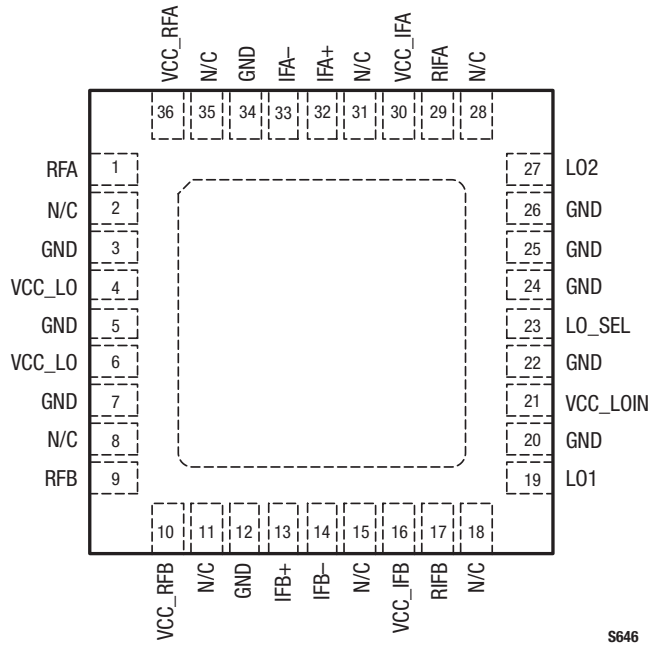

Figure 2. SKY73084-11 Pinout - 36-Pin MCM (Top View)

Table 1. SKY73084-11 Signal Descriptions

| Pin | Name | Description | Pin | Name | Description |
|-----|---------|------------------------------|-----|----------|--------------------------------|
| 1 | RFA | RF channel A input | 19 | LO1 | Local oscillator #1 input |
| 2 | NC | No connect | 20 | GND | Ground |
| 3 | GND | Ground | 21 | VCC_LOIN | DC supply, +5 V |
| 4 | VCC_LO | DC supply, +5 V | 22 | GND | Ground |
| 5 | GND | Ground | 23 | LO_SEL | Local oscillator switch select |
| 6 | VCC_LO | DC supply, +5 V | 24 | GND | Ground |
| 7 | GND | Ground | 25 | GND | Ground |
| 8 | NC | No connect | 26 | GND | Ground |
| 9 | RFB | RF channel B input | 27 | LO2 | Local oscillator #2 input |
| 10 | VCC_RFB | DC supply, +5 V | 28 | NC | No connect |
| 11 | NC | No connect | 29 | RIFA | IF channel A bias control |
| 12 | GND | Ground | 30 | VCC_IFA | DC supply, +5 V |
| 13 | IFB+ | IF channel B positive output | 31 | NC | No connect |
| 14 | IFB- | IF channel B negative output | 32 | IFA+ | IF channel A positive output |
| 15 | NC | No connect | 33 | IFA- | IF channel A negative output |
| 16 | VCC_IFB | DC supply, +5 V | 34 | GND | Ground |
| 17 | RIFB | IF channel B bias control | 35 | NC | No connect |
| 18 | NC | No connect | 36 | VCC_RFA | DC supply, +5 V |

Functional Description

The SKY73084-11 is a high gain diversity mixer, optimized for base station receiver applications. The device consists of two diversity channels, each consisting of a low loss RF balun, high linearity passive mixer, and a low noise IF amplifier.

LO amplifiers are also included that allow the SKY73084-11 to connect directly to the output of a Voltage Controlled Oscillator (VCO). This eliminates the extra gain stages needed by most discrete passive mixers. A Single Pole, Double Throw (SPDT) switch has been included to select between two different LO inputs for frequency hopping applications (i.e., GSM).

RF Baluns and Passive Mixer

The RF baluns provide a single ended input, which can easily be matched to $50\ \Omega$ using a simple matching circuit. The RF baluns offer very low loss and excellent amplitude and phase balance.

The high linearity mixer is a passive, double balanced mixer that provides a very low insertion loss, and excellent 3rd Order Input Insertion Point (IIP3) and linearity performance.

Additionally, the balanced nature of the mixer provides for excellent port-to-port isolation.

LO Buffers and SPDT LO Switch

The LO buffers allow the input power of the SKY73084-11 to be programmed in the range of -6 to +6 dBm. The LO section has been optimized for high-side LO injection. However, the LO can be driven over a wide frequency range with only slight degradation in performance.

A high isolation SPDT switch allows the SKY73084-11 to be used for frequency hopping applications. This switch provides greater than 60 dB of LO1 to LO2 isolation:

| LO_SEL Logic: | State: |
|---------------|-------------|
| High | LO1 enabled |
| Low | LO2 enabled |

For applications that do not require frequency hopping, LO_SEL is fixed to one state and the appropriate LO input is used.

IF Amplifier

The SKY73084-11 includes high dynamic range IF amplifiers that follow the passive mixers in the signal path. The outputs require a supply voltage connection using inductive chokes. These choke inductors should be high-Q and have the ability to handle 200 mA or greater.

A simple matching network allows the output ports to be matched to a balanced $200\ \Omega$ impedance. The IF amplifiers are optimized for IF frequencies between 50 and 250 MHz. The IF amplifiers can be operated outside of this range, but with a slight degradation in performance.

Electrical and Mechanical Specifications

The absolute maximum ratings of the SKY73084-11 are provided in Table 2. The recommended operating conditions are specified in Table 3 and electrical specifications are provided in Table 4.

Typical performance characteristics of the SKY73084-11 are illustrated in Figures 3 through 31.

Table 2. SKY73084-11 Absolute Maximum Ratings¹

| Parameter | Symbol | Min | Typ | Max | Units |
|------------------------------------|------------------|-----|-----|------|-------|
| Supply voltage, +5 V (VCC1 - VCC7) | VCC | 4.5 | 5.0 | 5.5 | V |
| Supply current | I _{CC} | | 370 | 430 | mA |
| RF input power | P _{RF} | | | +20 | dBm |
| LO input power | P _{LO} | | 0 | +20 | dBm |
| Operating case temperature | T _C | -40 | | +85 | °C |
| Junction temperature | T _J | | | +150 | °C |
| Storage case temperature | T _{STG} | -40 | | +150 | °C |

¹ Exposure to maximum rating conditions for extended periods may reduce device reliability. There is no damage to device with only one parameter set at the limit and all other parameters set at or below their nominal value.

Nominal thermal resistance (junction to center ground pad) is 5.1 °C/W.

ESD HANDLING: *Although this device is designed to be as robust as possible, electrostatic discharge (ESD) can damage this device. This device must be protected at all times from ESD when handling or transporting. Static charges may easily produce potentials of several kilovolts on the human body or equipment, which can discharge without detection. Industry-standard ESD handling precautions should be used at all times.*

Table 3. SKY73084-11 Recommended Operating Conditions

| Parameter | Symbol | Min | Typ | Max | Units |
|------------------------------------|-----------------|------|------|------|-------|
| RF frequency range | F _{RF} | 300 | | 500 | MHz |
| LO frequency range ¹ | F _{LO} | 350 | | 600 | MHz |
| IF frequency range | F _{IF} | 50 | | 250 | MHz |
| Supply voltage, +5 V (VCC1 - VCC7) | VCC | 4.75 | 5.00 | 5.25 | V |
| Supply current | I _{CC} | | 370 | | mA |
| LO input power | P _{LO} | -6 | 0 | +6 | dBm |
| LO select logic: high | LO_SELH | 2.2 | | | V |
| low | LO_SELL | | | 0.8 | V |
| Operating case temperature | T _C | -40 | | +85 | °C |

¹ The SKY73084-11 has been optimized for high-side LO injection. However, the LO can be used outside of the specified frequency range with degraded performance.

Table 4. SKY73084-11 Electrical Specifications¹

(Voltage Supply = +5 V, T_c = +25 °C, L_O = 0 dBm, RF Frequency = 350 MHz, IF Frequency = 90 MHz, L_O Frequency = 440 MHz, Unless Otherwise Noted)

| Parameter | Symbol | Test Condition | Min | Typ | Max | Units |
|--|---------------------|---|-------|-------|------|-------|
| Conversion gain | G | FRF = 328 to 388 MHz, VCC = 4.75 to 5.25 V, PL _O = -3 to +3 dBm | 7.5 | 9.8 | | dB |
| Gain variation over temperature | | FRF = 350 MHz, T _c = -40 to +85 °C | | ±1 | | dB |
| Noise figure | NF | FRF = 350 MHz | | 9.4 | 11.0 | dB |
| Noise figure variation over temperature | | FRF = 350 MHz, T _c = -40 to +85 °C | | ±0.8 | | dB |
| Noise figure with a blocker signal | NF _{BLK} | Blocking signal input power = +8 dBm | | 18 | 25 | dB |
| Third order input intercept point | IIP3 | FRF = 350 and 350.8 MHz, PRF = -10 dBm/each tone, VCC = 4.75 to 5.25 V, PL _O = -3 to +3 dBm | +23.5 | +25.2 | | dBm |
| Input IP3 variation over temperature | | FRF = 350 and 350.8 MHz, T _c = -40 to +85 °C | | ±0.4 | | dB |
| Third order output intercept point | OIP3 | FRF = 350 and 350.8 MHz, PRF = -10 dBm/each tone, VCC = 4.75 to 5.25 V, PL _O = -3 to +3 dBm | | +35 | | dBm |
| 2RF - 2L _O | 2x2 | PRF = -10 dBm | | -63 | -57 | dBc |
| 3RF - 3L _O | 3x3 | PRF = -10 dBm | | -85 | -70 | dBc |
| 4RF - 3L _O | 4x3 | PRF = 0 dBm | | -102 | -95 | dBc |
| Input 1 dB compression point | IP1dB | | +9.5 | +13.2 | | dBm |
| Output 1 dB compression point | OP1dB | | | +22.0 | | dBm |
| L _O 1 to L _O 2 isolation | | FRF = 350 MHz, F _L _O = 440 MHz | 40 | 63 | | dB |
| Channel-to-channel isolation | | FRF = 350 MHz, F _L _O = 440 MHz | 37 | 41 | | dB |
| RF to IF isolation | | FRF = 350 MHz | 30 | 76 | | dB |
| L _O leakage: | | | | | | |
| 1xL _O to RF port | | FRF = 350 MHz, F _L _O = 440 MHz | | -40 | -25 | dBm |
| 2xL _O to RF port | | | | -28 | -22 | dBm |
| 3xL _O to RF port | | | | -50 | -28 | dBm |
| 4xL _O to RF port | | | | - | -28 | dBm |
| 1xL _O to IF port | | | | -40 | -23 | dBm |
| L _O _SEL input | | | -20 | +150 | +250 | μA |
| L _O switching time | | | | | 1.0 | μs |
| RF port input return loss | Z _{IN_RF} | With external matching components | 11 | | | dB |
| L _O port input return loss | Z _{IN_LO} | With external matching components | 14 | | | dB |
| IF port input return loss | Z _{OUT_IF} | With external matching components | 14 | | | dB |

¹ Performance is guaranteed only under the conditions listed in this table.

Typical Performance Characteristics

(Voltage Supply = +5 V, Tc = +25 °C, LO = 0 dBm, RF Frequency = 350 MHz, IF Frequency = 90 MHz, LO Frequency = 440 MHz, Unless Otherwise Noted)

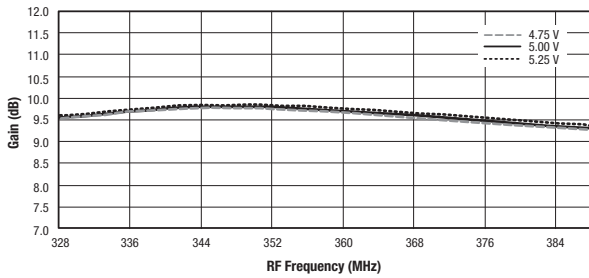

Figure 3. Mixer A Gain vs. Frequency and Supply Voltage

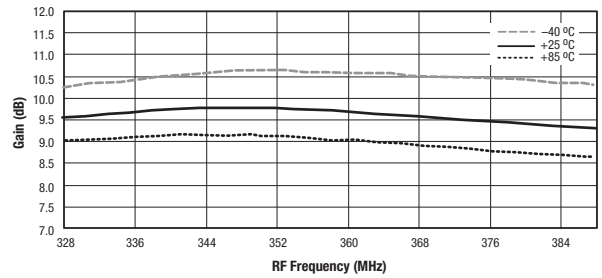

Figure 4. Mixer A Gain vs. Frequency and Temperature

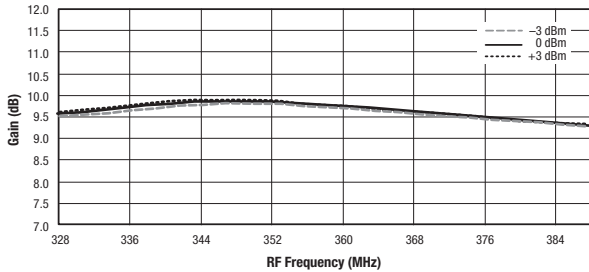

Figure 5. Mixer A Gain vs. Frequency and LO Power

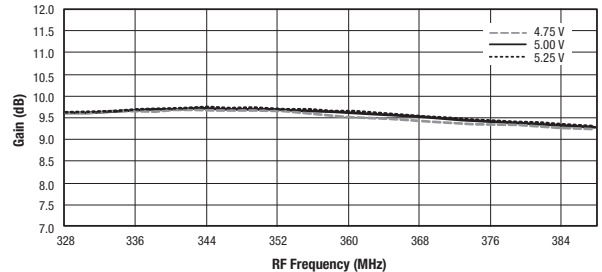

Figure 6. Mixer B Gain vs. Frequency and Supply Voltage

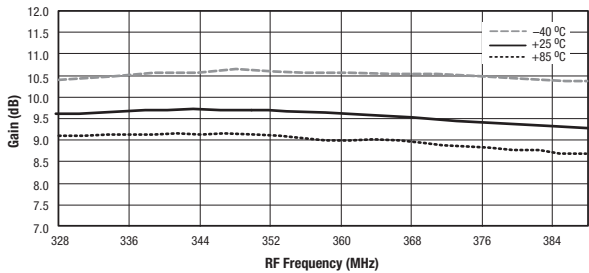

Figure 7. Mixer B Gain vs. Frequency and Temperature

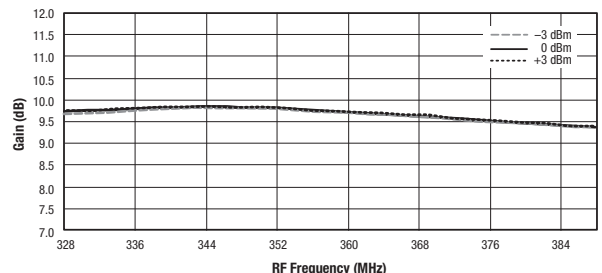

Figure 8. Mixer B Gain vs. Frequency and LO Power

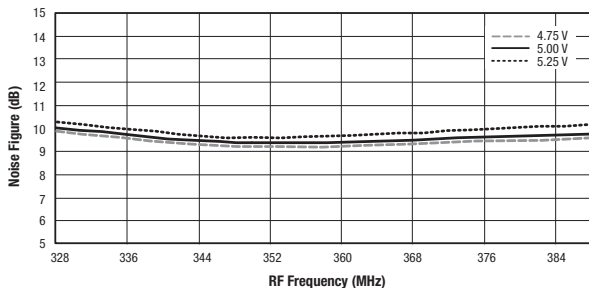

Figure 9. Mixer A Noise Figure vs. Frequency and Supply Voltage

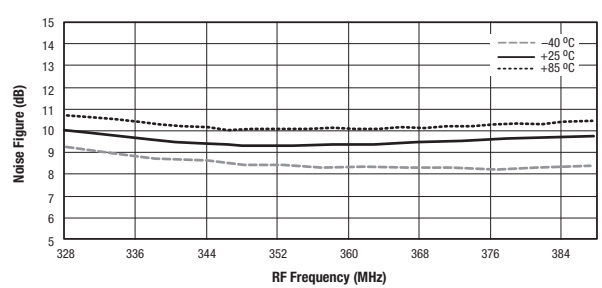

Figure 10. Mixer A Noise Figure vs. Frequency and Temperature

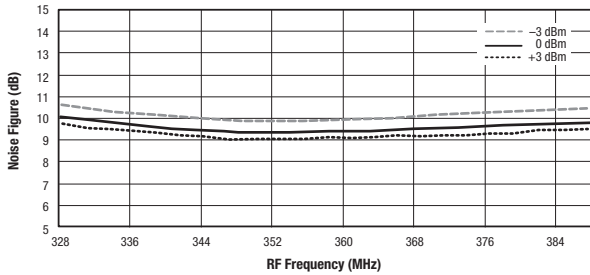

Figure 11. Mixer A Noise Figure vs Frequency and LO Power

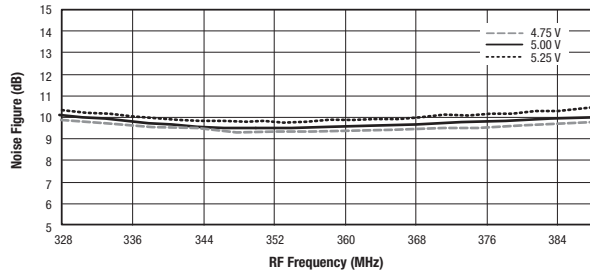

Figure 12. Mixer B Noise Figure vs Frequency and Supply Voltage

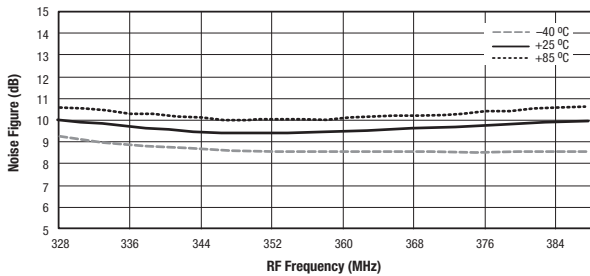

Figure 13. Mixer B Noise Figure vs Frequency and Temperature

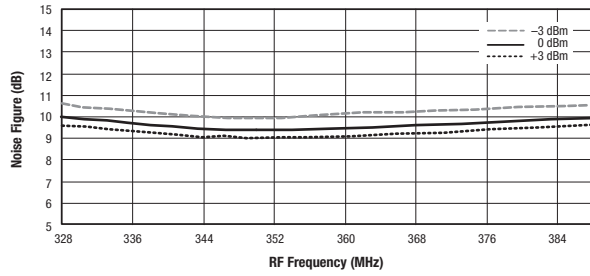

Figure 14. Mixer B Noise Figure vs Frequency and LO Power

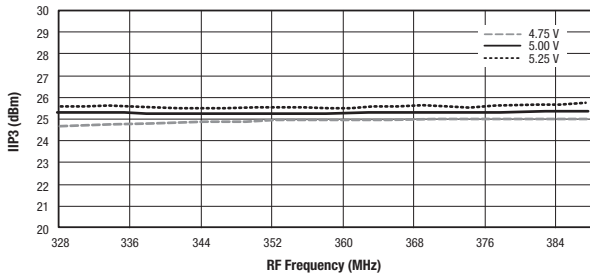

Figure 15. Mixer A IIP3 vs Frequency and Supply Voltage

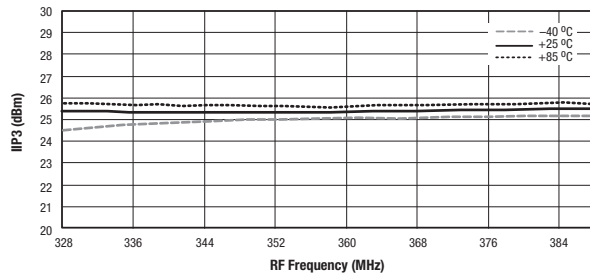

Figure 16. Mixer A IIP3 vs Frequency and Temperature

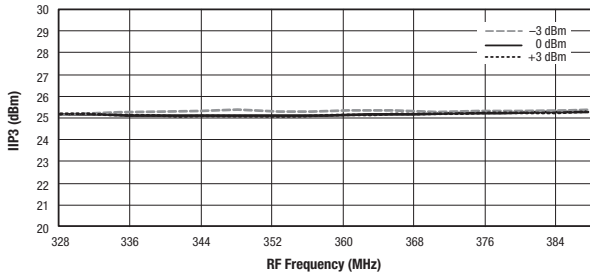

Figure 17. Mixer A IIP3 vs Frequency and LO Power

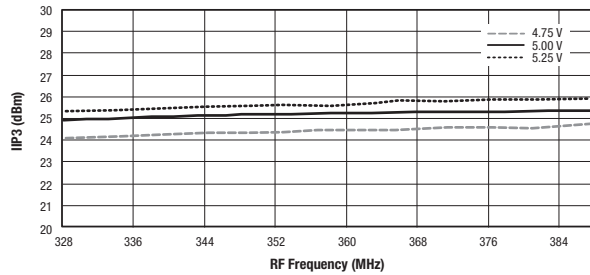

Figure 18. Mixer B IIP3 vs Frequency and Supply Voltage

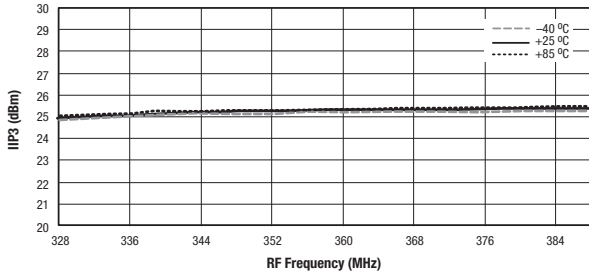

Figure 19. Mixer B IIP3 vs Frequency and Temperature

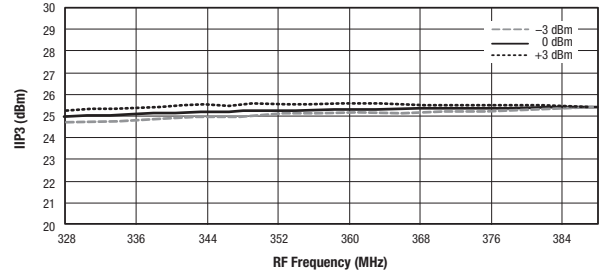

Figure 20. Mixer B IIP3 vs Frequency and LO Power

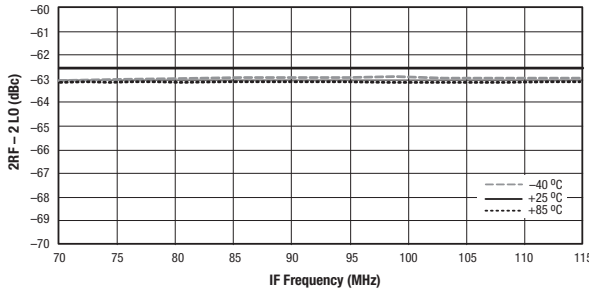

Figure 21. Mixer A 2RF-2LO vs IF Frequency and Temperature

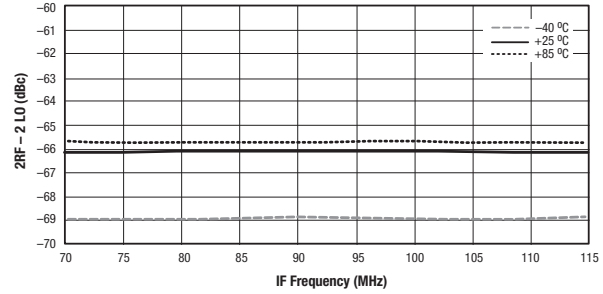

Figure 22. Mixer B 2RF-2LO vs IF Frequency and Temperature

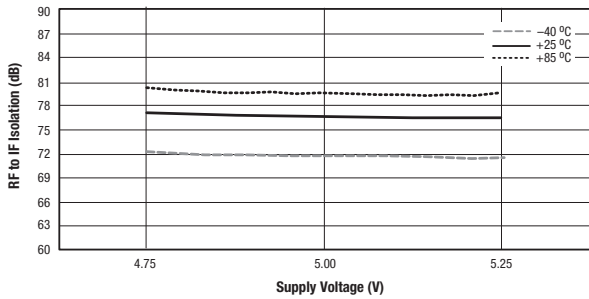

Figure 23. Mixer A RF to IF Isolation vs Supply Voltage and Temperature

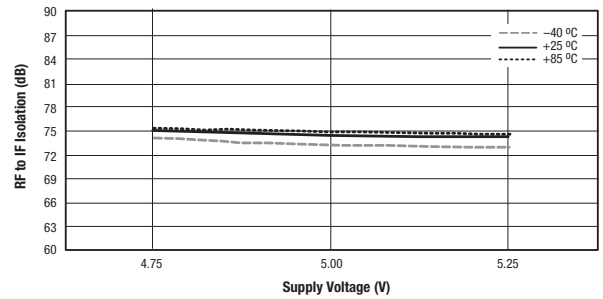

Figure 24. Mixer B RF to IF Isolation vs Supply Voltage and Temperature

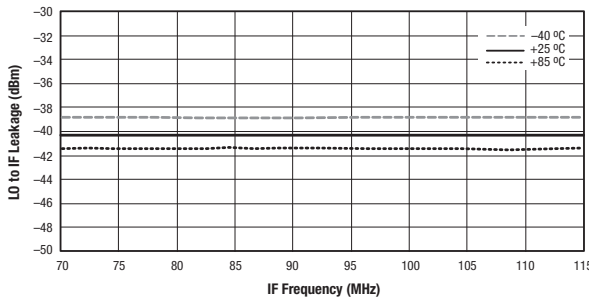

Figure 25. Mixer A LO to IF Leakage vs IF Frequency and Temperature

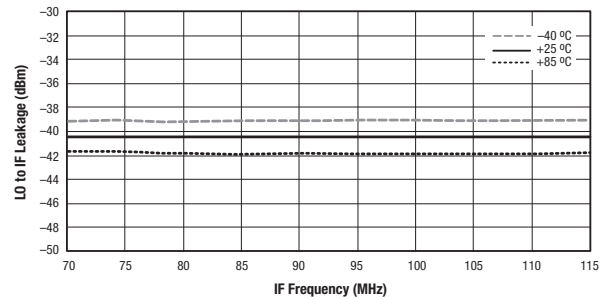

Figure 26. Mixer B LO to IF Leakage vs IF Frequency and Temperature

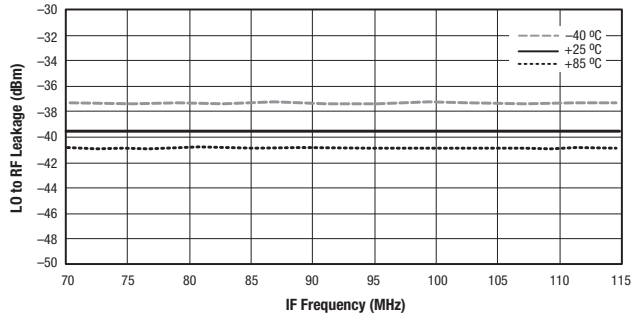

Figure 27. Mixer A LO to RF Leakage vs IF Frequency and Temperature

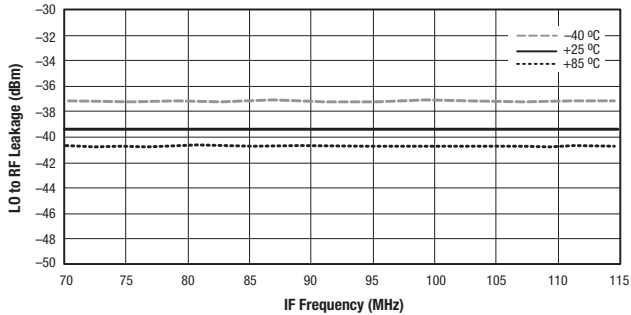

Figure 28. Mixer B LO to RF Leakage vs IF Frequency and Temperature

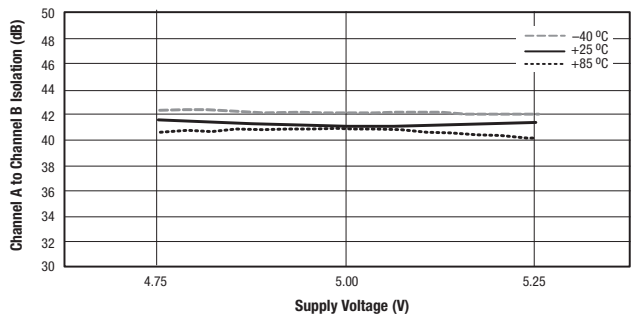

Figure 29. Channel A to Channel B IF Isolation vs Supply Voltage and Temperature

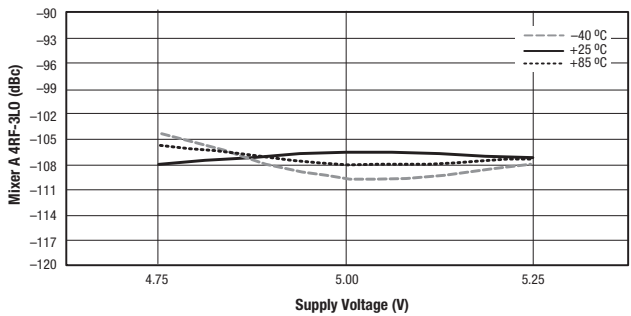

Figure 30. Mixer A 4RF to 3LO vs Supply Voltage and Temperature

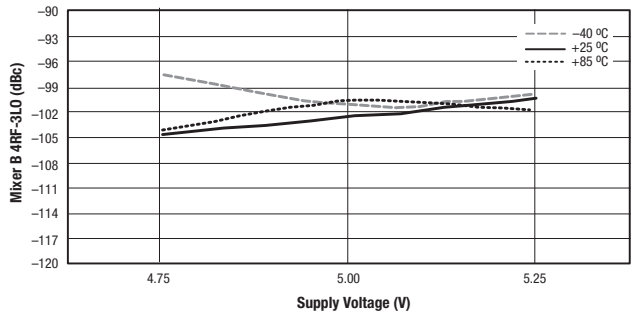

Figure 31. Mixer B 4RF to 3LO vs Supply Voltage and Temperature

Evaluation Board Description

The SKY73084-11 Evaluation Board is used to test the performance of the SKY73084-11 downconversion mixer. An assembly drawing for the Evaluation Board is shown in Figure 32 and the layer detail is provided in Figure 33. A schematic diagram of the SKY73084-11 Evaluation Board is shown in Figure 34.

Circuit Design Configurations

The following design considerations are general in nature and must be followed regardless of final use or configuration:

1. Paths to ground should be made as short as possible.
2. The ground pad of the SKY73084-11 has special electrical and thermal grounding requirements. This pad is the main thermal conduit for heat dissipation. Since the circuit board acts as the heat sink, it must shunt as much heat as possible from the device. Therefore, design the connection to the ground pad to dissipate the maximum wattage produced by the circuit board.
3. Skyworks recommends including external bypass capacitors on the VCC voltage inputs of the device.
4. Components L5, L6, L14, and L15 (see Figure 34) are high-Q low loss inductors. These inductors must be able to pass currents in excess of 200 mA DC.
5. Components R1 and R2 (see Figure 34) set the bias current for the IF amplifiers. Skyworks recommends that these resistors have a tolerance of $\pm 1\%$ to optimize performance consistency of the SKY73084-11. These resistors are not required for the Evaluation Board to operate as specified in Tables 3 and 4.

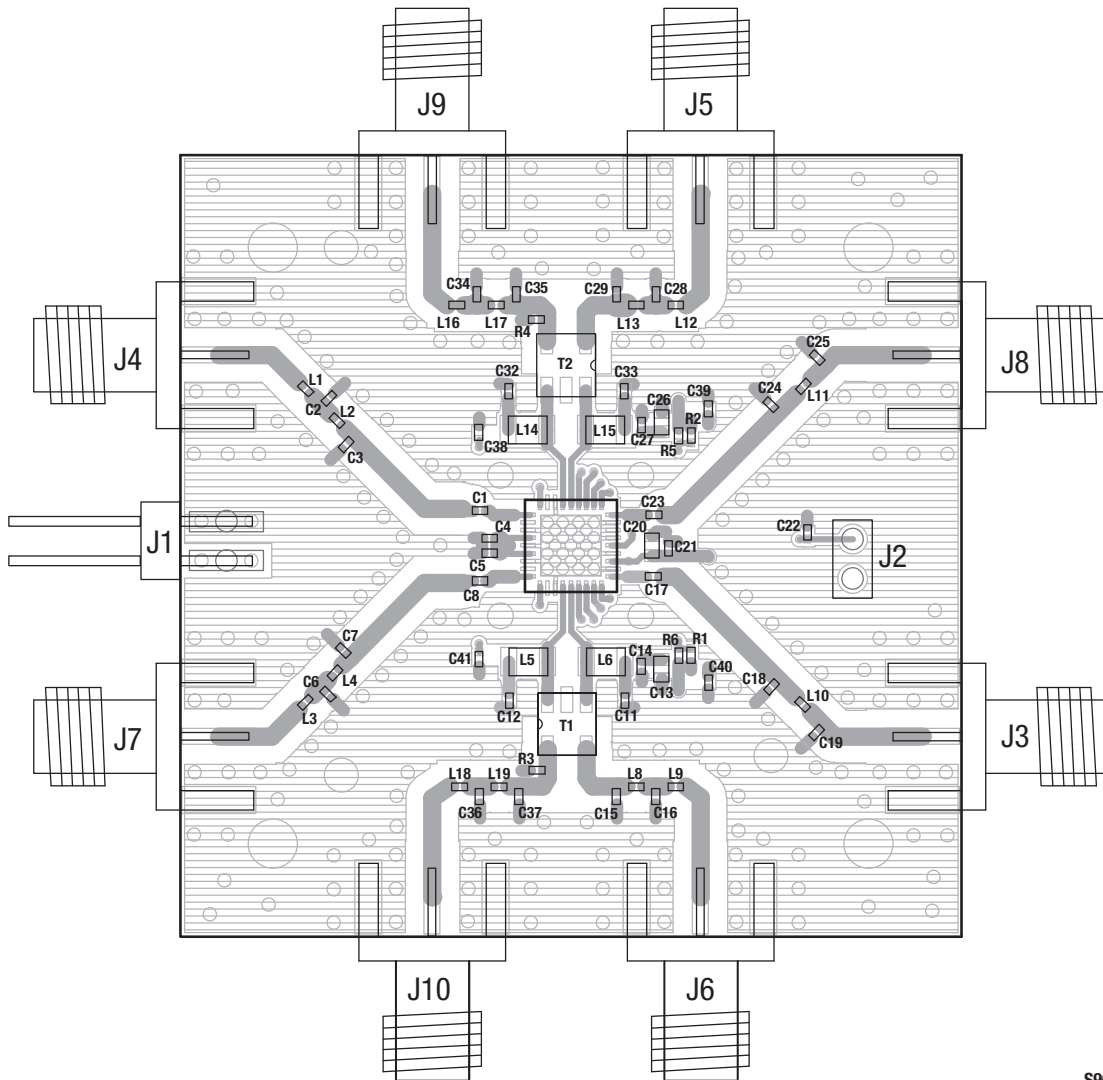

S905

Figure 32. SKY73084-11 Evaluation Board Assembly Diagram

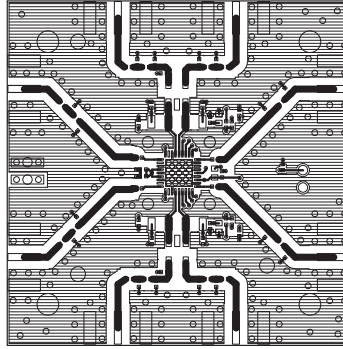

Layer 1: Top -- Metal

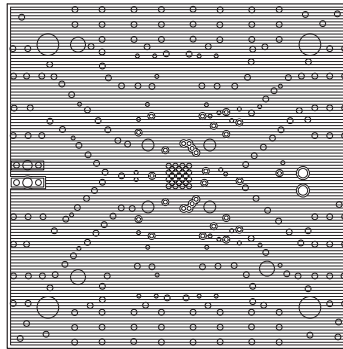

Layer 2: Ground

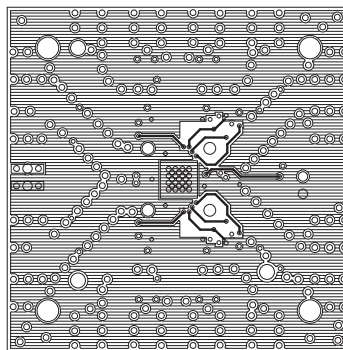

Layer 3: Power Plane

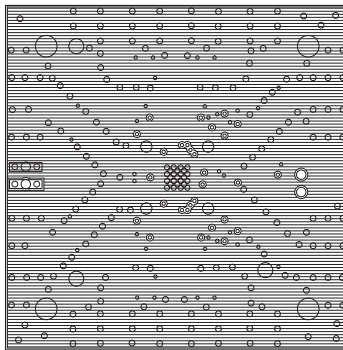

Layer 4: Solid Ground Plane

S904

Figure 33. SKY77024 Evaluation Board Layer Detail

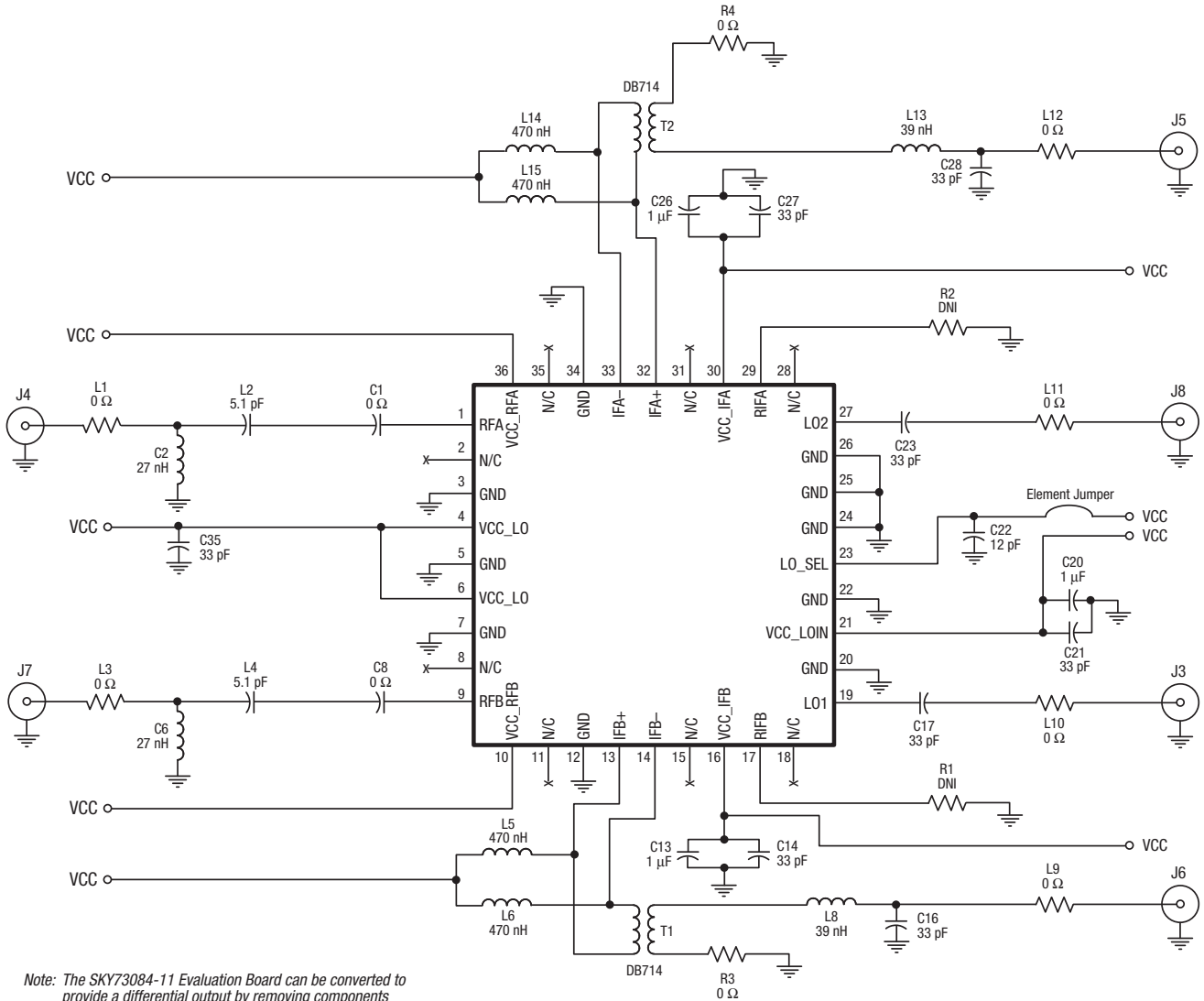

Note: The SKY73084-11 Evaluation Board can be converted to provide a differential output by removing components T1, T2, R3, and R4.

Some component labels may be different than the corresponding component symbol shown here. Component values, however, are accurate as of the date of this Data Sheet.

S1237

Figure 34. SKY73084-11 Evaluation Board Schematic

Package Dimensions

The PCB layout footprint for the SKY73084-11 is provided in Figure 35. Figure 36 shows the package dimensions, and Figure 37 provides the tape and reel dimensions.

Package and Handling Information

Since the device package is sensitive to moisture absorption, it is baked and vacuum packed before shipping. Instructions on the shipping container label regarding exposure to moisture after the container seal is broken must be followed. Otherwise, problems related to moisture absorption may occur when the part is subjected to high temperature during solder assembly.

The SKY73084-11 is rated to Moisture Sensitivity Level 3 (MSL3) at 260 °C. It can be used for lead or lead-free soldering. For additional information, refer to the Skyworks Application Note, *PCB Design & SMT Assembly/Rework Guidelines for MCM-L Packages*, document number 101752.

Care must be taken when attaching this product, whether it is done manually or in a production solder reflow environment. Production quantities of this product are shipped in a standard tape and reel format.

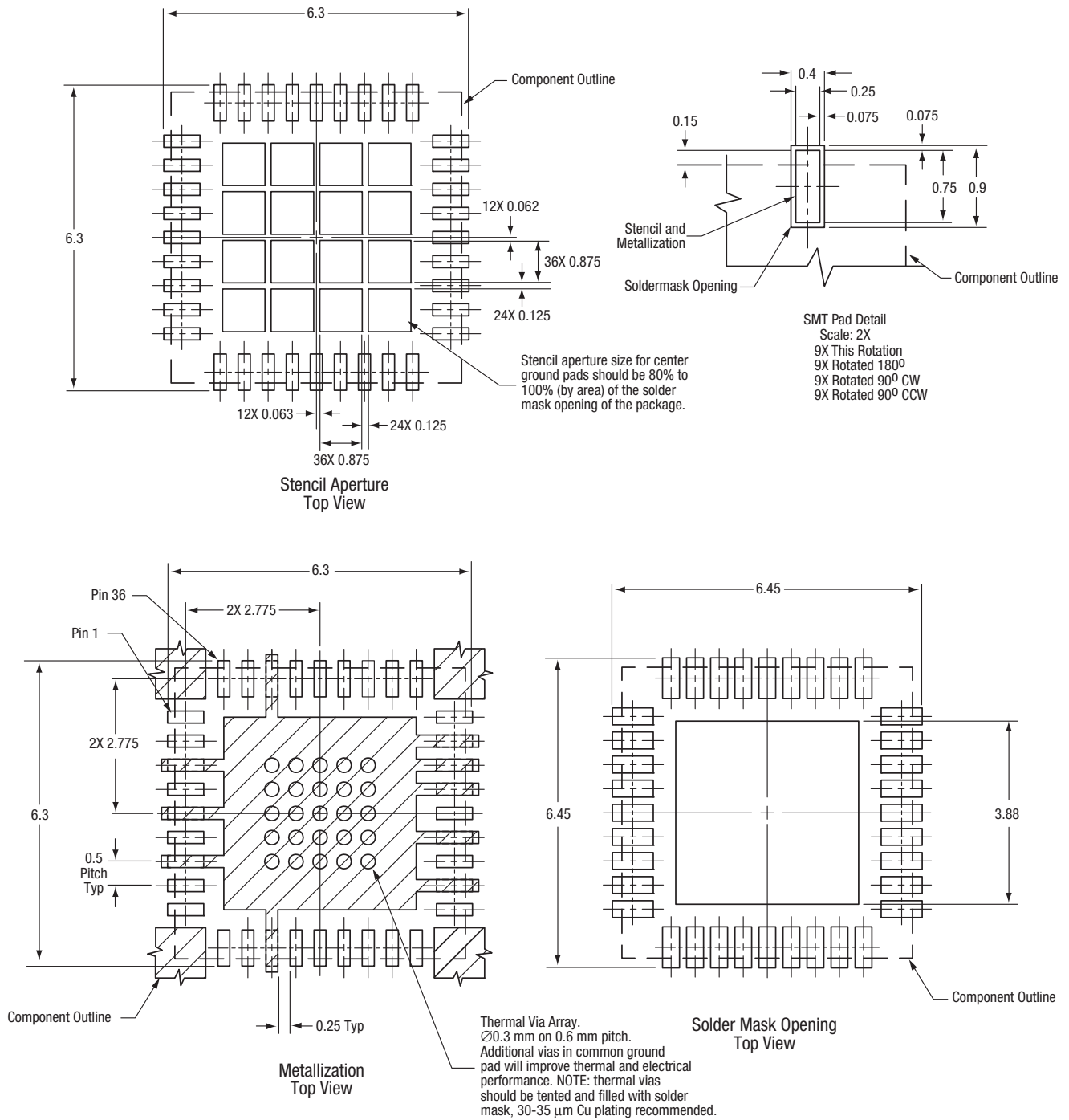

S1125

Figure 35. PCB Layout Footprint for the SKY73084-11

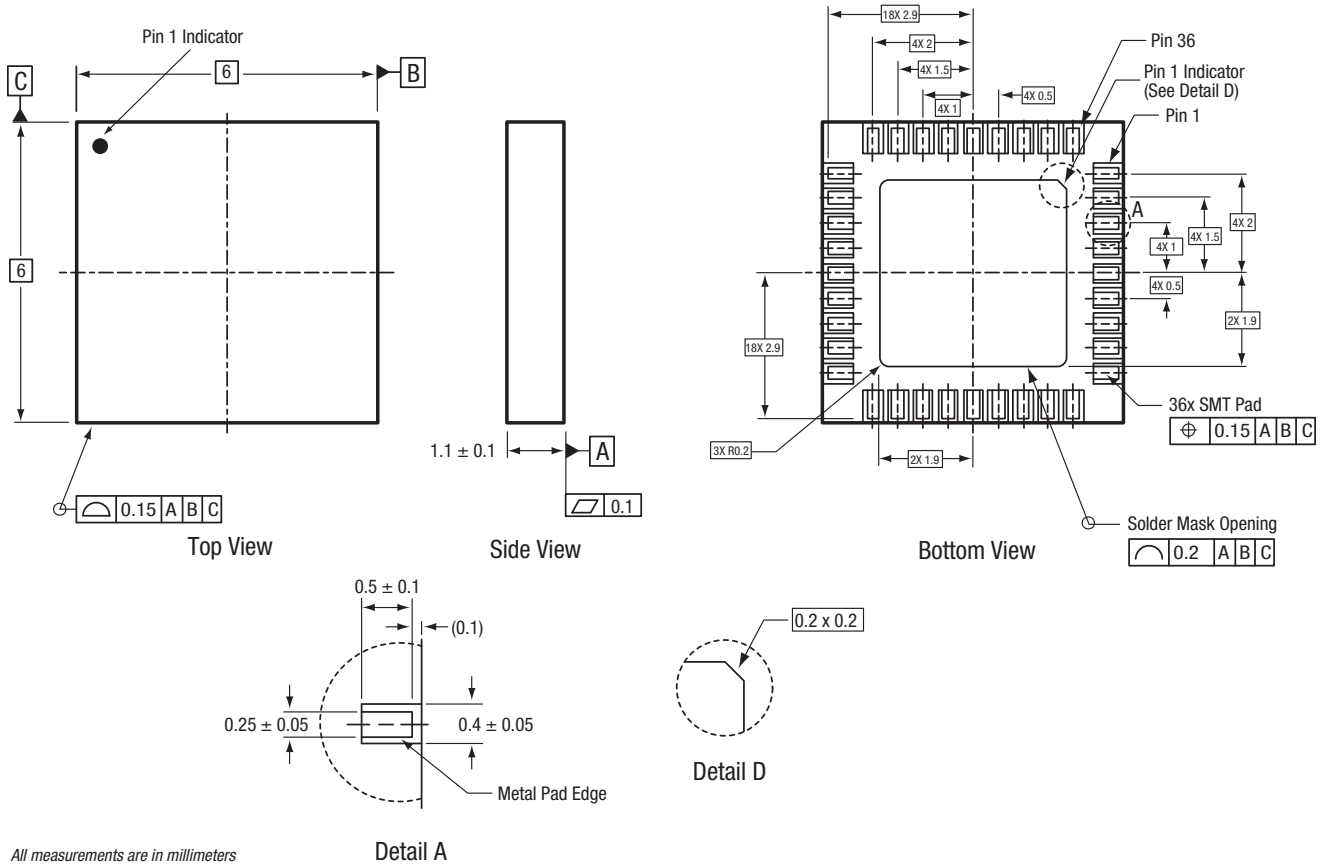

All measurements are in millimeters

Pads are solder mask defined on one edge and metal defined on three edges.

Dimensioning and tolerancing according to ASME Y14.5M-1994

S689_A

Figure 36. SKY73084-11 Package Dimensions

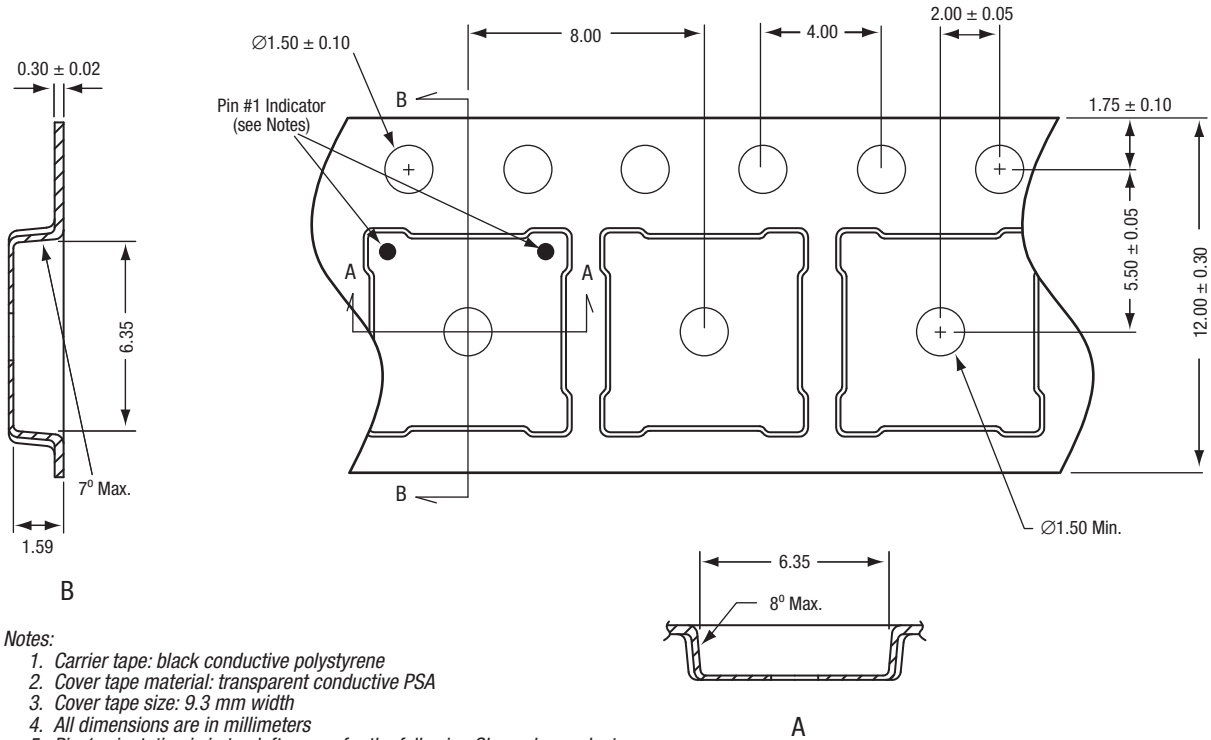

- Notes:
1. Carrier tape: black conductive polystyrene
 2. Cover tape material: transparent conductive PSA
 3. Cover tape size: 9.3 mm width
 4. All dimensions are in millimeters
 5. Pin 1 orientation is in top left corner for the following Skyworks products:

SKY73022-21, -31
 SKY73023-21, -31

For all other 6 x 6 mm MCM/RFLGA products, pin 1 orientation is in top right corner.

S1183

Figure 37. SKY73084-11 Tape and Reel Dimensions

Ordering Information

| Part Number | Product Description | Evaluation Board Part Number |
|-------------|-------------------------------------|------------------------------|
| SKY73084-11 | 300 to 500 MHz Downconversion Mixer | TW17-D570 |

Copyright © 2008, 2009, 2011, 2018 Skyworks Solutions, Inc. All Rights Reserved.

Information in this document is provided in connection with Skyworks Solutions, Inc. (“Skyworks”) products or services. These materials, including the information contained herein, are provided by Skyworks as a service to its customers and may be used for informational purposes only by the customer. Skyworks assumes no responsibility for errors or omissions in these materials or the information contained herein. Skyworks may change its documentation, products, services, specifications or product descriptions at any time, without notice. Skyworks makes no commitment to update the materials or information and shall have no responsibility whatsoever for conflicts, incompatibilities, or other difficulties arising from any future changes.

No license, whether express, implied, by estoppel or otherwise, is granted to any intellectual property rights by this document. Skyworks assumes no liability for any materials, products or information provided hereunder, including the sale, distribution, reproduction or use of Skyworks products, information or materials, except as may be provided in Skyworks Terms and Conditions of Sale.

THE MATERIALS, PRODUCTS AND INFORMATION ARE PROVIDED “AS IS” WITHOUT WARRANTY OF ANY KIND, WHETHER EXPRESS, IMPLIED, STATUTORY, OR OTHERWISE, INCLUDING FITNESS FOR A PARTICULAR PURPOSE OR USE, MERCHANTABILITY, PERFORMANCE, QUALITY OR NON-INFRINGEMENT OF ANY INTELLECTUAL PROPERTY RIGHT; ALL SUCH WARRANTIES ARE HEREBY EXPRESSLY DISCLAIMED. SKYWORKS DOES NOT WARRANT THE ACCURACY OR COMPLETENESS OF THE INFORMATION, TEXT, GRAPHICS OR OTHER ITEMS CONTAINED WITHIN THESE MATERIALS. SKYWORKS SHALL NOT BE LIABLE FOR ANY DAMAGES, INCLUDING BUT NOT LIMITED TO ANY SPECIAL, INDIRECT, INCIDENTAL, STATUTORY, OR CONSEQUENTIAL DAMAGES, INCLUDING WITHOUT LIMITATION, LOST REVENUES OR LOST PROFITS THAT MAY RESULT FROM THE USE OF THE MATERIALS OR INFORMATION, WHETHER OR NOT THE RECIPIENT OF MATERIALS HAS BEEN ADVISED OF THE POSSIBILITY OF SUCH DAMAGE.

Skyworks products are not intended for use in medical, lifesaving or life-sustaining applications, or other equipment in which the failure of the Skyworks products could lead to personal injury, death, physical or environmental damage. Skyworks customers using or selling Skyworks products for use in such applications do so at their own risk and agree to fully indemnify Skyworks for any damages resulting from such improper use or sale.

Customers are responsible for their products and applications using Skyworks products, which may deviate from published specifications as a result of design defects, errors, or operation of products outside of published parameters or design specifications. Customers should include design and operating safeguards to minimize these and other risks. Skyworks assumes no liability for applications assistance, customer product design, or damage to any equipment resulting from the use of Skyworks products outside of stated published specifications or parameters.

Skyworks and the Skyworks symbol are trademarks or registered trademarks of Skyworks Solutions, Inc. or its subsidiaries in the United States and other countries. Third-party brands and names are for identification purposes only, and are the property of their respective owners. Additional information, including relevant terms and conditions, posted at www.skyworksinc.com, are incorporated by reference.